

# Wellness systems.



# Technology for all senses.

We have been perfecting our products since 1928. With an eye for detail, and a philosophy based on functionality and dependability we develop unusual well-being solutions for spas and wellness facilities.

Technology for the senses that will delight your guests.

Trautwein baths and tables offer the very best in wellness appliances. Close cooperation with therapists and doctors, together with our own experience and expertise form the basis of our global success. Our numerous patents plus the many innovative features found in our equipment speak for themselves. You will find Trautwein products in 83 countries. The Castello del Sole in Ascona and the AIDA club cruise ships are just two companies convinced by the quality and tangible outcomes delivered by our sophisticated wellness products. You can find more references at [www.trautwein-gmbh.com](http://www.trautwein-gmbh.com) or at the back of this brochure.



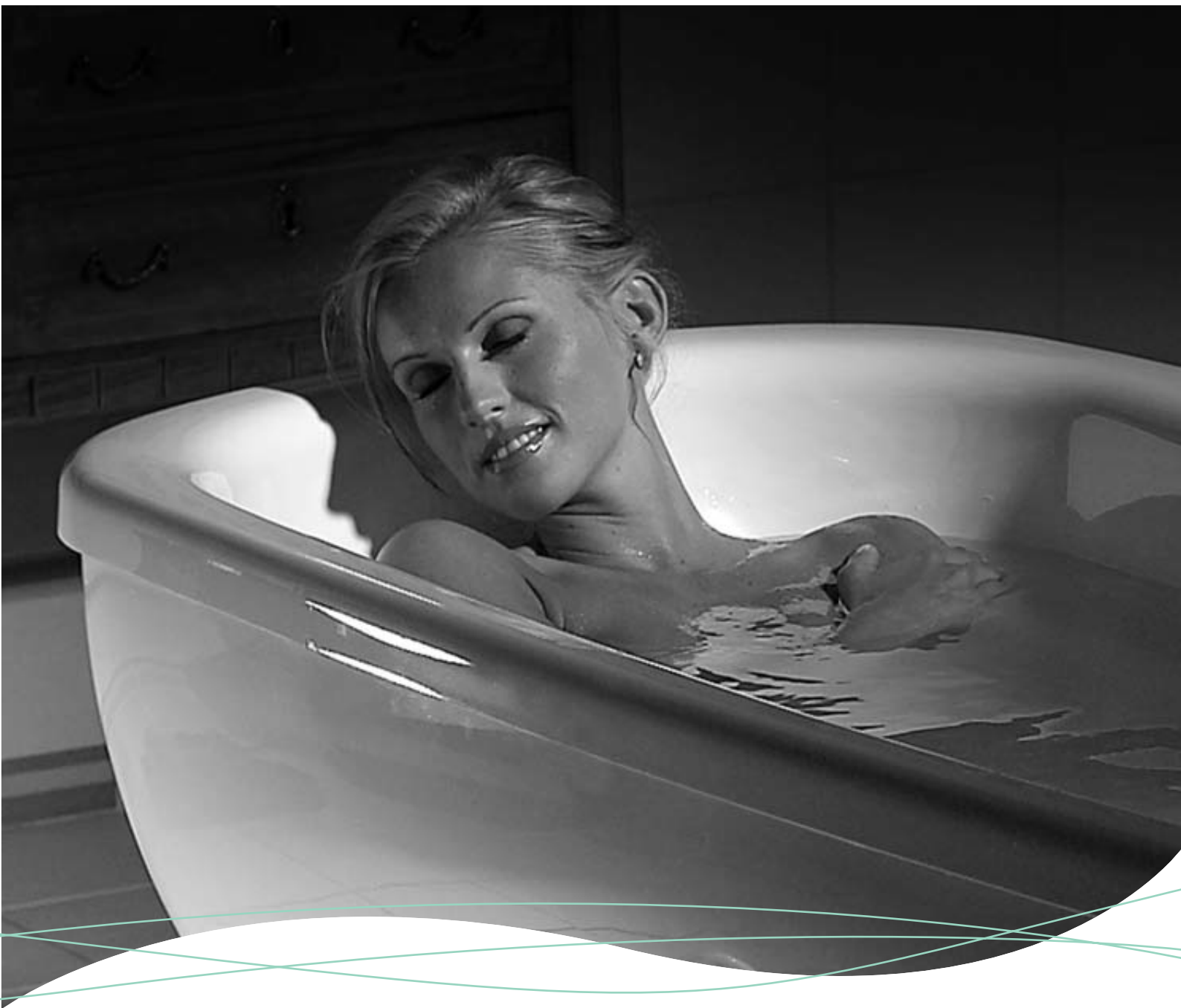

# When everything has to be perfect.

If everything's perfect, you are most likely using Trautwein products. The high demands we place on ourselves are your guarantee for effectiveness and an unbeatable lifespan of reliability.

Time and again we surprise our customers with original solutions. You'll find advanced technology and lots of intelligent ideas in each of our highly functional and easy-to-use wellness systems. What is more, our products come in a wide variety of designs and materials, and in a range of modern colours providing an attractive complement to any room decor.



## TOP QUALITY.

High quality materials are essential to the durability of a product. This is why Trautwein baths are made of a superior **sanitary acrylic** material and only high quality fittings are used. The fully dyed, easy-care material retains its hygienically smooth surface and brilliant shine for decades.

## WELLNESS COMBINED WITH EXCELLENT VALUE.

Nowadays, candles and a sweet-smelling aroma are not enough to impress a Wellness guest – they can have this at home at a much cheaper price. This is why Trautwein baths offer much more ... underwater massage, sound waves and coloured light to name but a few of our original details. Guests will recognise these wonderful benefits and after one Trautwein bath will want to repeat the experience!

# Contents.

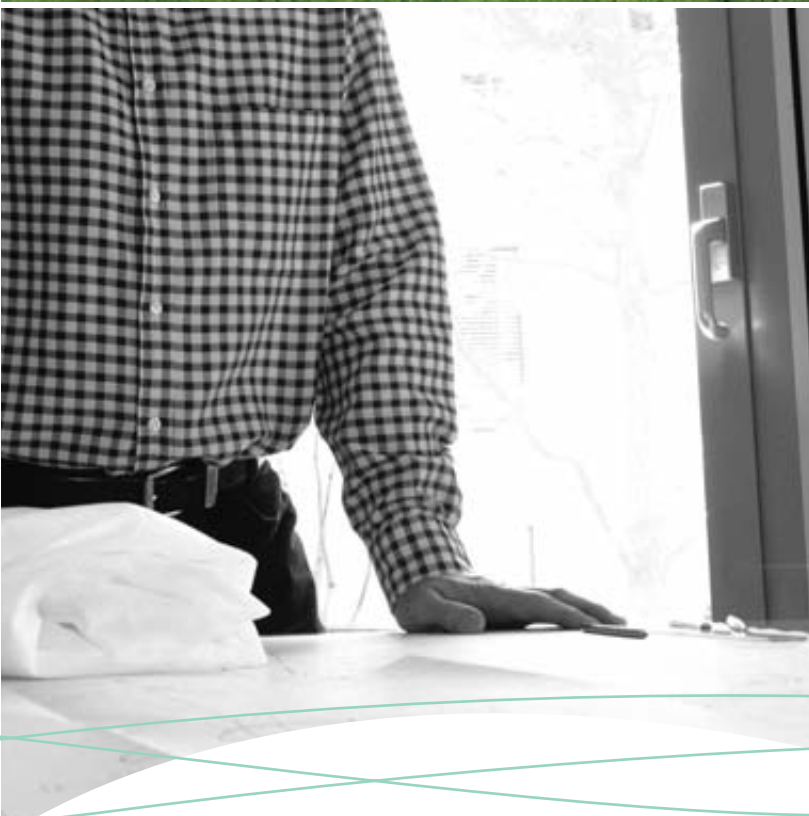

## TECHNICAL DETAILS.

Pre-assembly drawings and detailed technical descriptions are provided in the main catalogue for all equipment available. Bath and covering materials in the Trautwein range of colours are offered at no extra charge.



Hydroxeur® 8-13  
 Overview of Hydroxeur® 17 A



California Twin & Rendezvous 14-17  
 Overview of Hydroxeur® 17 A



Vis à Vis & Sole Mio 18-19



Revital Wellness Bed 20-21



Twaèli 22-23



Thermo-Spa & Lady-Spa 24-29



AquaThermoJet 30-31



Wet massage table 32-33



Vichy Rainbow Shower 34-35



Final hints 36-39  
 References  
 About us



# Aromatic bathing pleasure.



A pleasing aroma turns your bath into a luxurious experience. Trautwein offers professional bath additives containing natural essential oils and plant extracts for a stress-relieving, aromatic massage bath. Our **bath additives** are highly concentrated so very little of the product is required: one bottle lasts for up to 50 baths. Trautwein is always developing new, innovative products to perfect the bathing experience. You can find the latest information on our website.



## SPECIALLY FOR HYDROXEUR® WHIRLPOOLS.

Our bath additives have been specially formulated for the Hydroxeur® whirlpool. The surge bath emits fine swirls and eddies that create millions of tiny air bubbles. These bubbles mix our fragrant additives with the water creating a unique, aromatic champagne effect. The ultimate experience in therapeutic wellness bathing.

## TRAUTWEIN'S RANGE OF SCENTS.

- › **Harmony Spa** with chamomile: balancing and calming.
- › **Rosemary Spa**: refreshing and revitalising.
- › **Fantasy Spa** with mint and lemon balm: soothing and relaxing.
- › **Activity Spa** with mountain pine: revitalising and stimulating.
- › **Natural Spa** without a scent: for intensive additional bubbles, even when salts, algae, etc. are added.

# Simply try it out.



## TAKE A TEST BATH.

Experience Trautwein's philosophy of functionality and dependability. Discover the amazing quality of our products. You can try out our wellness systems at our headquarters in Emmendingen (Baden-Württemberg) and at the companies that sell our products. Treat yourself to a relaxing experience in one of our massage whirlpools or try out our other latest

innovations. Experience our products and we are sure you will be thrilled! Your guests could be, too!

We would be happy to tell you which of our distribution partners is nearest to you. Simply give us a call to make an appointment, with no obligations, on +49 (0) 7641 / 4677 – 30.





## HYGIENE.

The Hydroxeur® principle involves air being injected directly into the water pipes. All the air and water nozzles are supplied by the same system which means cleaning solutions and disinfectant are taken to hard-to-reach places. The automatic disinfecting programmes take care of hygiene, so you don't have to.

## FEATURES.

- › 60 to 290 water and air nozzles offer optimum pulsating vibration and jet massage.
- › Anatomical massages according to reflex zones. The nozzles are aimed towards the heart area.
- › Up to 8 water jet pumps for adding air.
- › Can be programmed for a customised massage.



# The Hydroxeur® principle.

Our Hydroxeur® whirlpool baths make use of a unique principle that mixes fine bubbles into the water. This champagne effect results in a top-quality underwater massage and has a therapeutic effect that is one of a kind. For those who prefer the finer things in life, Trautwein offers the **Royal, Atlantis, Florida** and **California** Hydroxeur® models. For us, top-quality wellness is not only about health benefits; it's also about technological features of the highest quality and innovation.

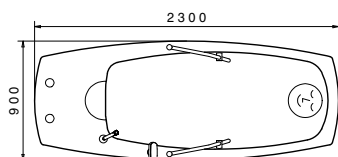
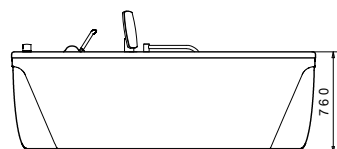

Omega cladding dimensions

Royal 600  
Atlantis 500  
Florida 300  
California 300

Tiled  
HYDROXEUR®

Additional information  
on page 17 A



Control panel  
ROYAL 600  
ATLANTIS 500



Control panel  
FLORIDA 300



Control panel  
CALIFORNIA 300



## ACCESSORIES AND SPECIAL FEATURES.

- › Massage hose for manual massage.
- › Additional nozzles for an even more intensive massage.
- › Colourful underwater lighting for the perfect wellness atmosphere.
- › Convenient automatic filling and emptying as standard.
- › A soft, inflatable pillow comes as standard.



## APPLICATIONS.

Relaxing in our Hydroxeur® baths is a treat for all your senses. Up to 290 ergonomically arranged nozzles provide an unusually intensive and bubbly massage. Emulating the skills of an experienced therapist, the massage begins at the soles of your feet and makes its way up to your neck, continuing this pleasant full-body experience for the duration of whichever programme you choose.

## EFFECTS.

- › Relieves tension and the pain of rheumatism & arthritis.
- › Reduces cellulitis.
- › Improves circulation.
- › Stimulates the lymphatic system.
- › Tautens the skin and connective tissue.
- › Has a slimming effect.

# Relaxation for all the senses.

Surround yourself the finest swirls of air and a myriad of tiny bubbles, bathe in a rainbow of colourful lighting and breathe in the finest of nature's fragrances. Enjoy gentle music and a rhythmic massage and in so doing bid the stress of your day farewell. Pamper all your senses. Your new-found equilibrium will have a positive effect on every aspect of your life. The **Hydroxeur®** is your very own therapist and offers complete relaxation with its wide variety of functions.

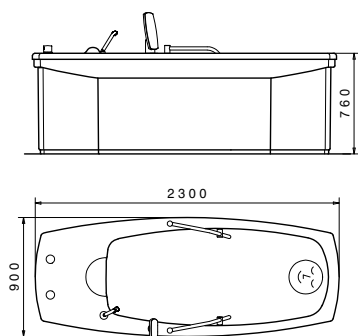

Alpha cladding dimensions

Royal 600  
Atlantis 500  
Florida 300  
California 300

Additional information  
on page 17 A



Alpha cladding,  
two colours



Alpha cladding,  
with bamboo



Alpha cladding,  
with mosaic

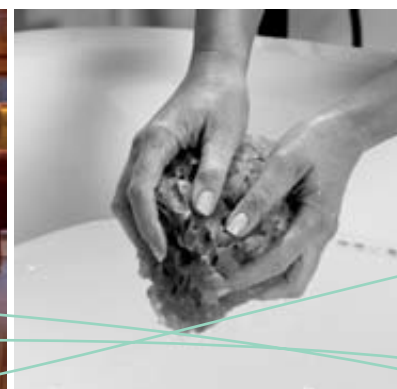
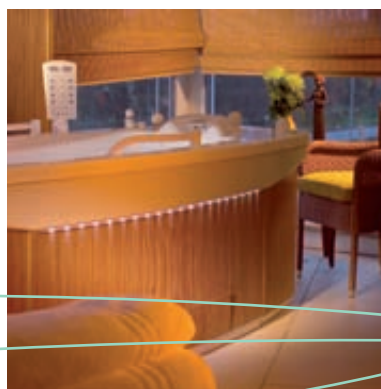

## SAFETY.

Your safety is one of our greatest concerns, which is why we have equipped the Hydroxeur® accordingly: handles ensure a safe bathing experience, and an adjustable shortener provides optimum support. An optional, integrated step also makes it easier to get in and out of the tub.

## DESIGN.

The Hydroxeur® is a quick-change artist: from design cladding in any colour of the Trautwein range to the illustrated variations, our baths will fit perfectly into your bathroom or spa interior. Numerous design options are available. There is also a ceramic version.



## TREATMENTS.

With a Hydroxeur® you can offer a wide variety of bathing options, be it a detox treatment, aromatherapy or thalassotherapy, all of which the Hydroxeur® is equipped to handle. The bath is also available with special fittings for thermal, mineral and sea water. Our wellness systems offer another invaluable advantage: once the guest is safely in the Hydroxeur® (or the Thermo-Spa) the therapist is then free for the duration of the programme to attend to other guests or tasks.



# Shorter models.

Due to their dimensions the **Florida 100**, **California 100** and **Diane 100** Hydroxeur® baths are perfect for smaller rooms. Thanks to the Hydroxeur® principle these offer a unique way to unwind at the end of the day even when space is limited.

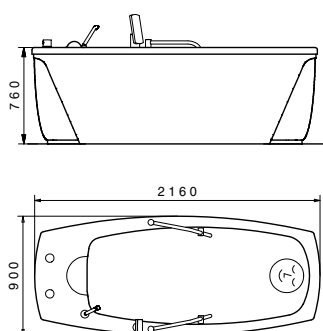

Dimensions  
Florida 100  
California 100  
Diane 100



Control panel  
FLORIDA 100



Control panel  
CALIFORNIA 100



Control panel  
DIANE 100

HYDROXEUR®  
with holding bow

Additional information  
on page 17 A

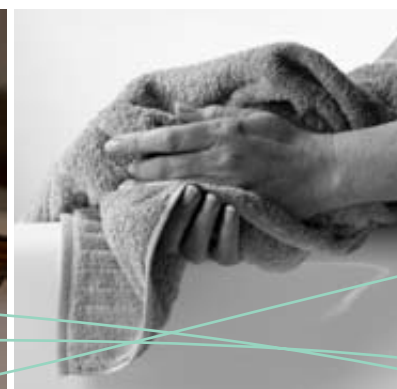

## CONTROLS.

- › Individually adjustable programmes.
- › Standard programmes.
- › Individual body zones can be turned on or off.
- › Customised treatment duration.
- › Constant massage using all nozzles.
- › Bath is filled, emptied and cleaned automatically.

# Hydroxeur® Couple Bath.

HYDROXEUR® CALIFORNIA TWIN



## CALIFORNIA TWIN & RENDEZVOUS.

These are two exceptional baths for couples that offer the same functions with different seating possibilities. In the California Twin you sit next to each other, whilst in the Rendezvous you sit opposite.

## VERSATILITY .

Our couple's baths are the perfect way to optimise financial return per square metre in a Wellness Centre or for the creation of relaxation oasis a private home. Due to their ease of operation, the Hydroxeur® couple baths are also ideally suited to hotel suites. They offer an exclusive in-room bathing event ... from aromatic massage to thalasso applications and relaxation baths.

# Wellbeing for two.

Trautwein is the only manufacturer in the world to offer Hydroxeur® whirl baths designed for two people to bathe together – the **California Twin** and the **Rendezvous**. As with all our Hydroxeur® baths, they offer four forms of Wellness: colour light therapy, water and air massage, sound wave massage and aroma therapy. You will find more information on the following page.

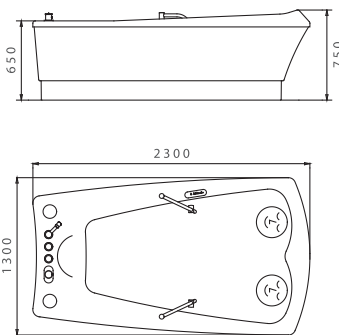

California Twin dimensions

Tiled  
CALIFORNIA TWIN  
Additional information  
on page 17 A



Plastic cladding  
California Twin white



Bathing guests can choose their favourite programme for the California Twin and Rendezvous by using the easy-to-operate controls.



The water flows into the bath silently via the cascade filler neck. The two-stage bath shortener provides safe bathing.



## COMFORT OF HANDLING.

At the push of a button, the California Twin and the Rendezvous are filled to the exact depth. Using our Hydroxeur® principle all air and water nozzles are supplied through a canal system. This way cleaning and disinfection agents can reach even hard-to-access areas using the pre-installed disinfection programme.

## DESIGN CALIFORNIA TWIN.

The California Twin can be delivered with a plastic cladding in a choice of different colours. In addition, a very beautiful effect can be created using indirect lighting on the cladding. As an alternative, a special frame is available that can be clad on-site with tiles or wood.



# Hydroxeur® Couple Baths.

HYDROXEUR® RENDEZVOUS



## INTENSELY TINGLING MASSAGE.

The couple baths, California Twin & Rendezvous, massage two bathing guests with 120 water and air nozzles. The finely whirling air and water swirls of the surge bath bring about relaxation, recovery and new energy. The Hydroxeur® principle creates an incomparably intense sensation that remains stored in the water for minutes... our fabled champagne effect!

## SOUND WAVE MASSAGE.

Dive into the world of sound. Be it rock, pop, classic or special relaxation music the sound you will hear in our Hydroxeur® baths is crystal clear. The bath itself serves as the speaker and transmits the sound waves through the water to the guest. The music is perceived in a totally unique way... as sound through your ears and also as vibrations through your body. A sensation that has to be experienced to be believed!



# Spoiling with surplus value.

Hydroxeur® couple baths simply offer more – an extraordinary Wellness experience that guests will remember positively for a long time, plus an inviting financial yield for the investor.

The time couples spend together is precious which is why an increasing number of couples like to enjoy their Wellness experience together, making couple's treatments a current trend.

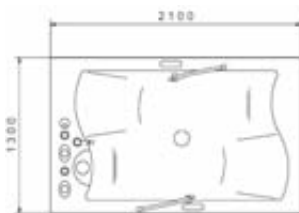

Dimensions Rendezvous



By pressing the button, the couple baths are filled to exactly the required level. Integrated thermostats ensure the water is always the desired temperature.



In the ergonomically-designed bath the guests relax in a seated position. On both sides a bath shortener, built in at the foot zone, adds to the guest's comfort and security.



The two bathing guests sit facing one another.



An additional thermostat (option) provides an even quicker filling of the bath.

## COLOUR LIGHT MODULE.

The flicker-free, full spectrum underwater illumination provided by the integrated high-performance lights tints the bath water with atmospheric rainbow colours. Coloured light has a regenerating and revitalising effect on the mind and emotions. The lighting can be adjusted to show either the full colour spectrum or a single colour only – the choice is yours.

## RENDEZVOUS DESIGN.

The Rendezvous is delivered with a special frame that can be adapted and clad on-site with tiles or wood. In this way it can be individually customised and integrated with ease into a home bathing area, hotel suite, Wellness centre, or a recovery institution.

# Hydroxeur® models.

		CONTROL PANEL									
		MODEL	Royal 600	Atlantis 500	Florida 300	Florida 100	California 300	California 100	California Twin	Rendezvous	Diane 100
MASSAGE	Number of persons		1	1	1	1	1	1	2	2	1
	Standard number of water/air nozzles		252	172	144	144	60	60	120	120	60
	Number of water/air nozzles increased to (optional)			230	172 290	172 290					
	Number of zone groups treated		8	8	5	5	1	1	2	2	1
	Number of body zones massaged		20	20	16	16	4	4	8	8	4
	Added air with champagne effect powered by water jet pump (Hydroxeur® principle)		●	●	●	●	●	●	●	●	●
	Added air warmed		●	●	●	●	●	●	●	●	●
	Stomach massage feature		+	+	+	+					+
Manual massage feature		+	+	+	+					+	
FEATURES	Stop/start button accessible to bather		●	●	●	●	●	●	●	●	●
	Chrome-plated design fittings		●	●	●	●	●	●	●	●	●
	Ergonomically shaped bath (220 litres)		●	●	●	●	●	●			●
	Pump output, litres/minute		850	850	400	400	250	250	400	400	250
	Power supply (other voltages on request)	Volts Hz	400 50	400 50	230 50	230 50	230 50	230 50	230 50	230 50	230 50
CLADDING	1. Alpha cladding		●	●	●		●				
	2. Alpha cladding, two colours		+	+	+		+				
	3. Alpha cladding, with bamboo		+	+	+		+				
	4. Alpha cladding, with stainless steel		+	+	+		+				
	5. Omega cladding (not with 2, 3 or 4)		+	+	+		+				
	6. External lighting		●	+	+		+		+		
	7. Tiling frame		+	+	+	+	+	+	+	●	+
	8. Cladding in RAL colours (standard = white)		+	+	+	+	+	+	+		+
OPTIONAL FEATURES	Colourful lighting with LED spots, number of spots		● 6	+ 4	+ 4	+ 4	● 2	● 2	● 4	● 4	
	Sound wave massage with music						●	●	●	●	
	Automatic bath filling		●	●	●	●	●	●	●	●	●
	Emergency call function		+	+	+	+	+	+	+	+	+
	Steps matching the cladding		●	●	●	●	●	●			●
HYGIENE	Hygiene pack (chlorine granules, Adisan, Bayromed)		+	+	+	+	+	+	+	+	+
	Automatic cleaning and disinfecting programme		●	●	●	●			+	+	
	Automatic disinfecting programme with chlorine according to the Austrian standard		+	+	+	+ <sup>①</sup>			+ <sup>①</sup>	+	
	Automatic rinsing programme		●	+	+	+					

Subject to technical changes

● = standard

+ = optional

① = only in combination with tiling frame

# Hydroxeur® in detail.

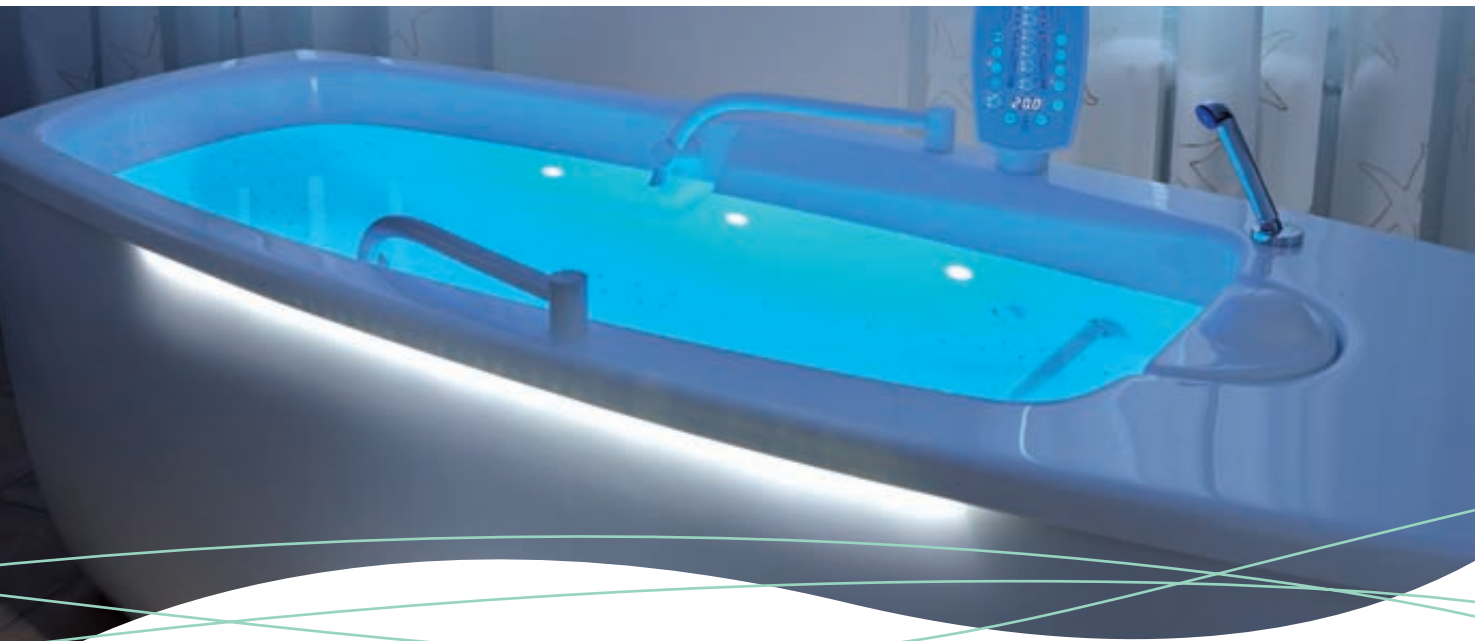

## USE.

- › An attractive, shell-shaped inlet fills the bath quietly and quickly.
- › A thermostat protects against scalding and guarantees the correct water temperature. The rated output is 48 l/min.

## LIGHTING.

- › Flicker-free and pure, full-spectrum underwater lighting. Integrated, powerful LED colours light up the bathwater with alternating colours of the rainbow. This chromotherapy has a regenerating and revitalising effect on your mind and emotions.
- › The optional, indirect LED lighting on the external cladding creates an atmospheric ambience.

# Wellness Bath Vis à Vis & Sole Mio.

VIS À VIS  
for single and couple baths



## SOUND WAVE MASSAGE.

Immerse yourself in the world of sound. Whether it's rock, pop, classic or special relaxation music the sound in our Wellness baths is crystal clear. The bath itself serves as the speaker and transmits the sounds waves through the water to the bathing guest. The music is perceived in a totally unique way... as sound through your ears and also as vibrations through your body.

18

## COLOURED LIGHT.

When the integrated, flicker-free, high power coloured LED lights are illuminated the surface of the bath water shimmers with atmospheric rainbow colours. This chromatic light has revitalising and regenerating effects – something many of us experience when springtime arrives after a long, dark winter. If you so choose, the lights can be adjusted to show only your favourite colour.



# Feeling the sound in the body.

The **Vis à Vis** offers you a unique combination of three forms of Wellness: colour light therapy, sound wave massage and aromatherapy. These generate a most effective micro-massage of all cells, organs and body parts. Your psyche is also influenced in a positive way. A sensation that has to be experienced to be believed. In our baths you will feel Beethoven with every fibre of your being! In the **Vis à Vis**, one or two people can enjoy the bath, whereas the **Solo Mio** is designed just for one person.

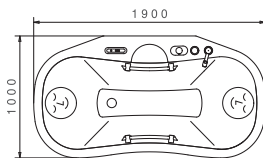
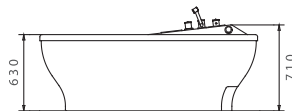
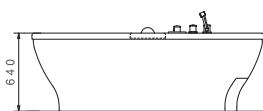

Dimensions Vis à Vis

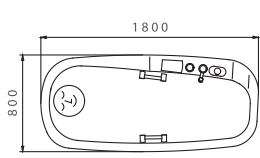

Dimensions Solo Mio



At the push of a button the Vis à Vis is filled via the cascade inlet up to the exact bathing depth, always to the desired temperature by means of a thermostat.



The model Solo Mio has space for one person.



The Vis à Vis has space for one or two people.

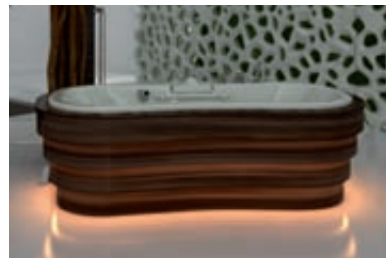

Here: special wooden version for Dubai project. All baths can be delivered with a frame for custom tiling on site.



The oil dispersion shower can be connected to any conventional shower hose.

## AROMA THERAPY & OIL DISPERSION BATH.

If you apply the right aromatic additives, bathing can turn into a real feast for the senses. The oil dispersion shower binds high-quality oil, in the form of ultra-fine droplets, into the bath water enabling it to be perfectly absorbed, leaving your skin as smooth as silk and as soft as velvet.

# Revital Wellness Bed.

REVITAL WELLNESS BED  
in black with cover in caramel



## OPERATION.

The Revital Wellness Bed provides an effective relaxation solution. Its easy-to-reach control panel is integrated unobtrusively near the head zone. This panel contains six easy-to-identify buttons, each operated by a single push. Three different relaxation programmes are available at the push of a button. The intensity of the massage as well as the volume of the music can be adjusted individually via the control panel.

## TECHNICAL DETAILS.

- › 3 Wellness programmes with an intuitive selection system.
- › High quality, robust cover available in three different colours.
- › Audio system for CDs or MP3 format, installed on-site.
- › Easy connection to a 230V socket.
- › Optional indirect lighting.
- › Optional connection for coin-operation.

# Modern Design Wonder.

The elegant **Revital Wellness Bed** allows you to experience a sense of deep relaxation, while its exclusive design makes it an attractive interior design feature. It is an excellent offering for relaxation zones, spa suites or wellness areas, as well as for a personal relaxation experience in your own private living room or to use as a warm haven to rest between sauna sessions.

A patent has been filed for this exceptional product. It operates on a principle unique to Trautwein. It has five tempered pillows filled with a liquid that allow the the couch to adapt perfectly to the contours of your body. An incomparably pleasant massage is given through a selection of three Wellness programmes, coupled with sound wave massage to the rhythm of music. You will leave your daily cares behind when you experience this wonderful relaxation couch!

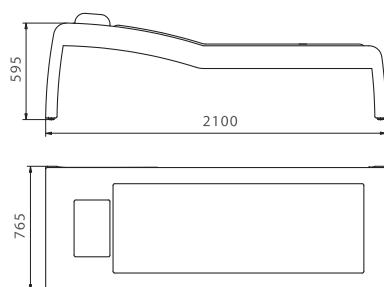

Dimensions Revital Wellness Bed

Revital Wellness Bed	
Length x width	2100 mm x 765 mm
Height	595 mm
Weight	170 kg
Load-bearing capacity	150 kg
Power supply	230 V, 50 Hz, 300 watts

- Cover in stone grey >
- Cover in caramel >>
- Cover in anthracite grey >>>

Wellness bed available  
in black or white.

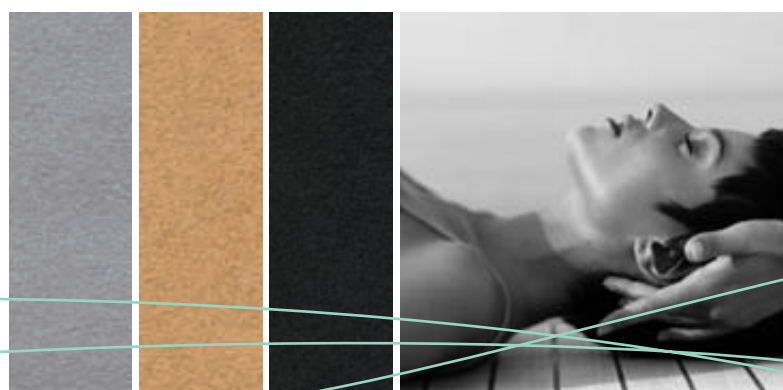

## TREATMENT PROGRAMMES.

**Programme 1** for a deeply relaxing experience: Your breathing adapts to a set rhythm due to the **respiratory frequency** oscillation feature. Your body experiences a state of absolute recovery.

**Programme 2** for an intensive feeling of well-being: **massaging vibrations**, directed towards the heart, ensure optimum regeneration and pamper your senses.

**Programme 3** lets you forget stress and the cares of everyday life: one cushion after the other is set to a fundamental vibration mode. **Revitalising impulses** increase your feeling of physical well-being and stimulate your sensory and motor system.

The intensity of the massage and the volume of the music are individually adjustable for all programmes.



# Twaèli – Thermo- & Relaxation Couch.

TWAÈLI

Upper shell of the couch black, bottom side of the couch white, pillows light-grey



## THERMO AND RELAXATION COUCH.

A tender, tingly feeling flows through your body to the rhythm of the music. You will hear gentle sounds and feel harmonious vibrations in every fibre of your being and with all your senses. Daily routine will disappear and give way to relaxation and well-being. The heated, ergonomically-designed laying surface with soft pillows will spoil you at the highest level of comfort.

## FOR RECOVERY AND WELLBEING.

The couch with an unbeatable relaxation factor spoils whenever you feel the need for it – after the sauna, at the end of a stressful day or simply in between treatments. Developed for modern professional sauna and wellness resorts, the Twaèli can equally enrich a luxurious private home.



# Viability and Wellbeing.

Depending on the equipment, the **Twaèli** is a chic and comfortable thermo couch or, when fully-equipped with soundwave massage, offers a warming, tranquilising effect on the body, mind and soul. Any genre of music can be played by means of an in-house audio system. The sound is crystal-clear, with the sound waves transmitted to the couch by a special technique. Ideal for recreation and relaxation the **Twaèli Design Couch** meets most requirements. By special order, the **Twaèli** can also be delivered without heat or sound - simply as a comfortable, modern relaxation bed.



The couch is available in black or white, the pillows in red or light grey. Other pillow colours are available on demand.



The hygienic smooth laying surface is of high-quality acrylic and easy to clean.



The upper surface can be overlaid with a high-quality ceramic plating.



In case of the model with soundwave massage, the operation is done via the ergonomically arranged and comfortable control panel.

Temperature and sound volume can be adjusted individually.



The adjustable headrest is set to the desired position by a handle.

Twaèli – Thermo- & Relaxation Couch	
Length x width	1750 x 820 mm
Height	420/930 mm
Weight	70 kg
Loading capacity	200 kg
Electrical connection	230 V, 50 Hz, 150 W

## EQUIPMENT VARIANTS.

- › Thermo couch: basic equipment with heating unit.
- › Thermo and relaxation couch: with additional soundwave massage available as an optional extra.
- › Design couch: no heat or sound.

# Thermo-Spa & Lady-Spa.

THERMO-SPA  
Design cladding, plain



## THERMO-SPA & LADY-SPA.

The Lady-Spa is the smaller version of the Thermo-Spa. Both floating couches can be equipped with various options. The Lady-Spa, with its smaller dimensions, was created particularly for small rooms and offers flexible use in spas, hotels, cosmetic institutes and in physical therapy centres.

## APPLICATIONS & EFFECT.

Our floating couch gives you an indescribable feeling of weightlessness. Depending on the options you choose, it also pampers you with sound waves and dry aqua massage. Both these products offer the many benefits of floatation... without having to take your clothes off. You are separated from the warm water by a layer of durable yet fully flexible plastic, giving a deeply relaxing experience that is reminiscent of being in the womb.

# Floating on Sounds.

When you experience our Thermo-Spa and Lady-Spa, weightlessness spreads slowly throughout your body and you feel incredibly light. Surrounded by relaxing warmth, a primordial feeling of security frees your body and mind from stress and discomfort. As soft sounds reach your ears and harmonious vibrations gently reverberate throughout your body, physical imbalances and everyday worries seem to melt away. Welcome to the world of **Thermo-Spa & Lady-Spa**, a unique wellness experience from Trautwein.

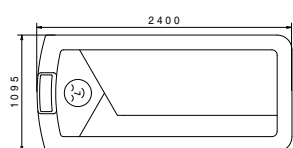
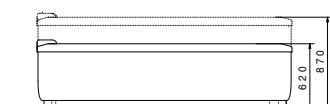

Dimensions Thermo-Spa  
standard cladding

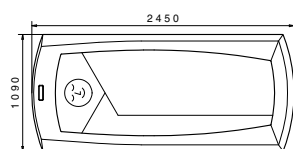
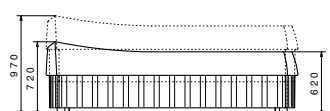

Thermo-Spa design cladding

## Examples of design THERMO-SPA



Design cladding,  
two colours,  
optional exterior lighting

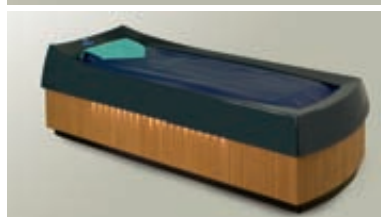

Design cladding,  
with bamboo,  
optional exterior lighting



Standard cladding, plain



Standard cladding  
Black with carbon  
appearance



Cladding  
with Alcantara,  
covered in faux leather



Wooden cladding,  
Zebrano / walnut

## SOFT PACK APPLICATIONS.

Our floating couches are suitable for all sorts of therapeutic and cosmetic body packs – from algae, hay and pomace to mud and fango. The guest lies down on the cushioned bed and is wrapped in a soft blanket. The warmth promotes circulation and opens the pores, allowing the skin to absorb the active ingredients for optimum results.

## DESIGN.

We have the perfect cladding design to match the ambience of any room. For colour and material selection, all the illustrated options plus numerous others are available. Simply let us know what you are looking for and we will find a way to deliver it. You will find variants for the Lady-Spa on the next page.

# Thermo-Spa & Lady-Spa.

LADY-SPA  
with standard cladding



## WELLBEING MODULE CONCERTO.

With the bath itself working as a loud speaker, the water on which you float vibrates allowing the sound you hear to be felt in your body. A unique Trautwein experience that has been described as out of this world!

## BREATHING RATE VIBRATION.

The breathing rate vibration transports you into a complete state of relaxation. Your breathing intuitively adapts to the preset rhythm of the wellbeing module. In harmony with the body, the soothing impulses ensure a deeply relaxing experience.



# Flexible all-rounder.

Just like every other Trautwein product, the **Thermo-Spa & Lady-Spa** meet all the highest quality standards that are integral to our philosophy. Many clever design details guarantee maximum comfort, even when used frequently. Regardless of whether it is used for therapeutic or cosmetic purposes its advanced, easy-to-use technology makes the Thermo-Spa well-equipped for any challenge.

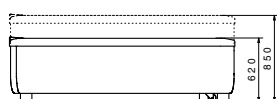

LADY-SPA with greyish-black cladding with bamboo and massage mat, height-adjustable

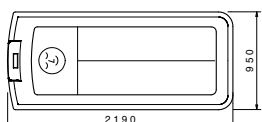

Dimensions Lady-Spa standard cladding

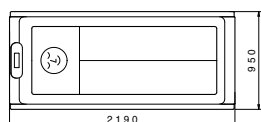
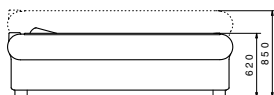

Dimensions Lady-Spa design cladding



LADY-SPA with design cladding

## AQUAJET MASSAGE MODULE.

Like an experienced therapist our floating couches massage from the thighs to the neck. Temperature-regulated water jets are expelled against the underside of the bed surface, releasing muscle tension whilst allowing you to experience the healing power of hydromassage without getting wet.

## OPTIONAL MASSAGE OVERLAY.

The light and soft overlay is simply put onto the floating couch. Thanks to this it is possible to offer different treatments in one room. The height-adjustable couch allows the client to get securely on and off, and also provides a good working posture for the therapist.

# Thermo-Spa & Lady-Spa.

THERMO-SPA  
with colour light module Aura

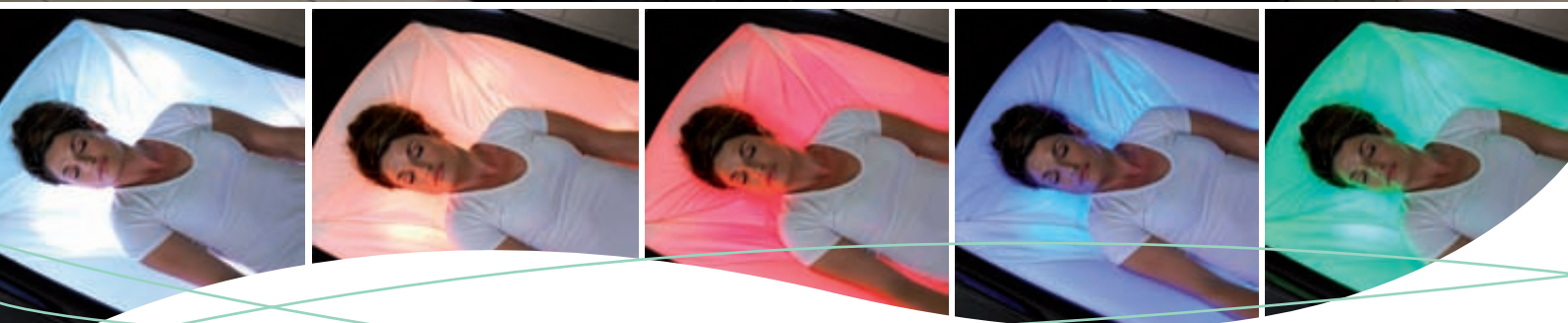

## AURA COLOUR LIGHT MODULE.

Floating in the light: When the integrated, flicker-free, high power coloured LED lights are illuminated the translucent special foil shimmers with atmospheric rainbow colours and

you float directly on a sea of revitalising and regenerating light. If you so choose, the lights can be adjusted to show only your favourite colour. Available in both the Thermo-Spa & Lady-Spa.

# An all-rounder for narrow places.

The **Thermo-Spa & Lady-Spa** floating couches allow professional whole body beauty treatments or heat packs to be offered simultaneously with the float, sound and colour experiences. Due to reduced therapist input and the possibility of parallel use they are very profitable. The guest gets pampered and relaxes, allowing the therapist can turn to other tasks. Connection in the room is kept simple – only a 230 V power socket is needed.

Floating Couch	Thermo-Spa	Lady-Spa
Length x width	2450 mm x 1090 mm	2190 mm x 950 mm
Height in lowered position	610 mm (seat height)	610 mm (seat height)
Height in raised position	850 mm	850 mm
Weight without water / With water	230 kg / 580 kg	210 kg / 520 kg
Floor load	340 kp/m <sup>2</sup>	260 kp/m <sup>2</sup>
Power supply	230 V, 50 Hz, 2500 watts	
Options	<ul style="list-style-type: none"> <li>› Concerto wellbeing module</li> <li>› AquaJet-massage-module</li> <li>› Aura Colour light module</li> <li>› Exterior lighting for design cladding</li> <li>› Massage overlay</li> </ul>	

Heating device



## TECHNICAL DETAILS THERMO-SPA & LADY-SPA.

- › Special tear-proof, flexible layer of plastic.
- › Odourless and resistant to oils and disinfectant.
- › Height adjustment perfected over decades.
- › Guests can end the programme themselves if they so wish.

## HEATING DEVICE.

Useful for heating and keeping cosmetic products warm like algae, oil, mud or stones for hot-stone treatments. Design of this feature is discreet as it is set into the working plate, with a discharge cock and digital controls for ease of use.



# AquaThermoJet.

AQUATHERMOJET  
Cladding, plain



## AQUAJET MASSAGE.

Like an experienced physiotherapist, the AquaThermoJet massages from the thighs to the neck. Instead of a therapist's hands you feel temperature-regulated water jets that massage through the layer of plastic, experiencing the healing power of water without getting wet. The AquaThermoJet massages 6 body zones via 24 nozzles.

## EFFECT.

- › Relieves tension.
- › Improves circulation and metabolism.
- › Tightens the connective tissue.
- › Stimulates the lymphatic system.
- › Reduces stress.
- › Improves wellbeing.



# Massage and relaxation.

The AquaThermoJet is convincing due to its flexibility of use. It is perfectly suited to the Wellness, Beauty and Fitness arenas where it can be self-service operated, by coin-machine if required. It is also used in medical practices or companies that provide health management for relaxation, as well as an offering provided between other medical treatments. The touchtronic control is easy to operate and can be moved by 180° allowing it to be easily controlled by a guest when they are lying down, or by a therapist standing above.

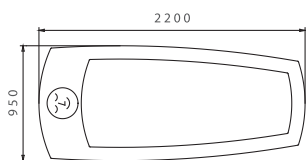
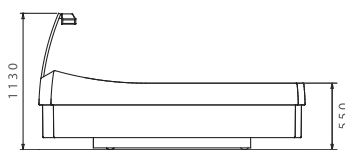

Dimensions AquaThermoJet

approved as medicinal product



Cladding, with lighting, plain



Cladding, with bamboo and lighting, plain



Cladding, two colours

AquaThermoJet	
Length x width x height	2200 mm x 950 mm x 550 mm
Suitable for	people up to 2 metres in height
Weight without/with water	130 kg /280 kg
Floor load	140 kp/m <sup>2</sup>
Power supply	230 V, 50 Hz, 2000 watts
Options	<ul style="list-style-type: none"> <li>› Sound wave massage and breathing rate regulation</li> <li>› Exterior lighting</li> <li>› Aura Colour light module</li> </ul>
Pump output	400 l / minute

## INCREASED PROFITABILITY.

Reduced personnel: Because the AquaThermoJet is so easy to use guests can enjoy it on their own. This means you have another wellness offering without requiring additional personnel. Depending on the number of applications and the pricing of treatments the AquaThermoJet can return its investment in just 1 year.

## OPTIONAL APPLICATIONS FOR WELLBEING.

Sound wave massage and breathing rate vibration complete the AquaThermoJet experience. The bath also acts as a loudspeaker – your entire body vibrates to the rhythm of the music. The integrated breathing rate vibration calms your breathing and has a deeply relaxing effect. An experience not to be missed!

# Ergolima Wet Massage Table

ERGOLIMA WET MASSAGE TABLE  
Lying surface and socle cladding black



## COMFORT FOR THE GUEST.

- › Adjustable head rest with nose slit.
- › Specially shaped arm rests for comfortable relaxation in the ventral position.
- › Table can be lowered to the height of a chair for getting on and off safely.
- › Spacious lying surface, suitable for average & larger guests.
- › Pleasant lying surface, thermostatically heated.

## COMFORT FOR THE THERAPIST.

- › Fully height-adjustable to allow an ergonomic posture – helps to minimise the risk of occupational injury.
- › Thermostat, changing valve, hand shower and pouring hose are fixed onto the rim of the table, all within easy reach.
- › Easy operation by a console in the table frame.
- › Channels on the side of the table, plus drains and a gently angled lying surface facilitate the draining of liquids.

# Maximum treatment comfort.

The luxurious **Ergolima Wet Massage Table** offers unsurpassed comfort for wet treatments. Its heated surface allows you to relax in a ventral position with your arms resting on the ergonomically shaped plateau next to your body. The head support is adjustable and can be positioned to meet your personal requirements. With this high level of comfort you can really enjoy your wet treatments such as soap brush massages, peelings, hammam or ayurvedic treatments. The Ergolima is patented, made of a high-quality, textured acrylic glass and is available in black or white. As with all of our products it is manufactured to the highest levels of excellence.

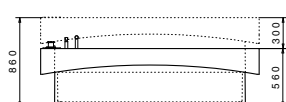

Dimensions Wet Massage Table  
with granite surface

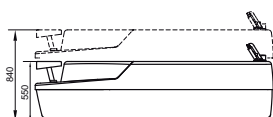

Dimensions Ergolima

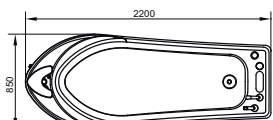
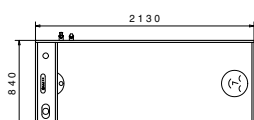

Height-adjustable head piece and lateral arm supports. Drain at the head piece, suitable for collecting oils.



Ergolima Wet Massage Table with high quality ceramic plating



Orient – Alima Wet Massage Table, lying surface white with plastic cladding white.



Wet Massage Table, with granite surface. Cladding with bamboo



Wet Massage Table with lifted soles cladding

## DESIGN.

Our Wet Massage Table offers many design options. In addition to the acrylic, textured surface available in 4 colours, we also offer different types of natural stone. This variety allows you to choose whichever style suits your interior design the best.

## SOPHISTICATED IN DETAIL.

The soles cladding below the lying surface can – in all models – be elevated electrically at the touch of a button. This is ideal for cleaning and servicing. If desired, a soap foam dispenser can also be installed.

# Vichy Rainbow Shower.

VICHY RAINBOW SHOWER



## RANGE OF USE.

The pleasant, relaxing and revitalising whole body shower treatments taken with a Vichy shower have a long-standing tradition. They are especially well-proven in hydro and thalasso therapy, as well as in the fitness, spa and wellness arenas.

## EFFECT.

The regular, evenly-applied shower can improve blood circulation resulting in enhanced oxygen transfer, plus purification and detoxication of the skin and internal organs. After a Vichy Rainbow Shower you will feel relaxed, refreshed and your skin will feel tighter.



# A tingly shower pleasure.

The Trautwein **Vichy Rainbow Shower** offers a brand new and unique shower experience using sophisticated technology coupled with exceptional design. The shower head is equipped with micro nozzles assembled in 2 rows. **It sways back and forth, showering your body from your feet up to your neck.** Very fine water jets massage your body simulating sea waves, a gentle rain shower or intensely stimulating drops – the choice is yours. Dissolved salt or nurturing oils can be added to the water to further increase your sense of well-being. The water flows over sparkling **Swarovsky crystals** that diffuse flicker-free LED coloured light onto your body for the ultimate relaxation shower. The Vichy Rainbow Shower needs 150-250 litres of water per treatment, the same as for a bath.

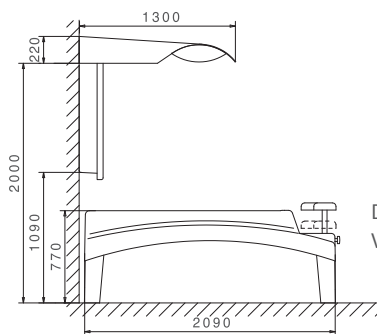

Dimensions  
Vichy-Rainbow-Shower

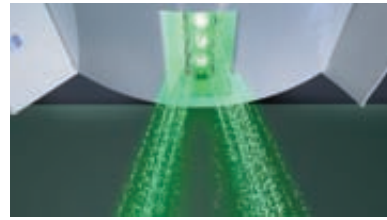

Shower jets  
with shiny coloured light.

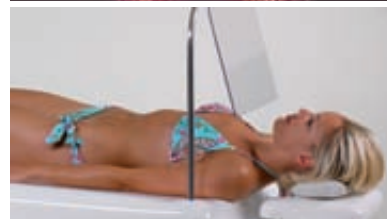
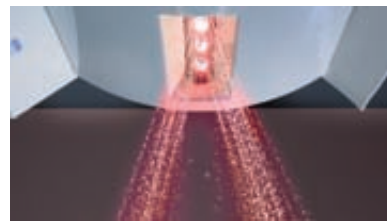
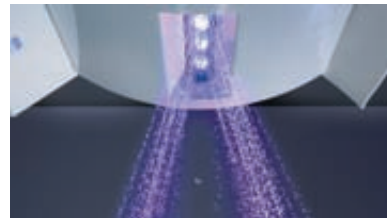

The couch provides  
optimal comfort for  
ventral as well as dorsal  
position.

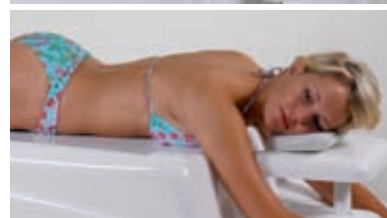

The face remains almost  
completely dry due to the  
insertable and  
adjustable splash guard.

## CONTROL PANEL.

The duration of the shower, the mixing of additives / salts and the disinfection cycle is regulated via a control panel. A thermostat ensures the water is a perfect temperature and removes the risk of scalding. Using a hand key the guest can integrate short, cold shower phases into the treatment to stimulate circulation.

## VICHY COUCH.

The comfortable couch made of a plastic material is ideally suited to wet areas. The lying surface is made of a high-quality, textured acrylic glass. It has a high degree of comfort due to the height-adjustable head board, the lower-positioned arm supports and the splash guard.

# Final hints.



## FOR THE PLANNING OF TREATMENT ROOMS IN A SPA OR WELLNESS AREA

### ROOM PLANNING

A balanced number of rooms for staff-intensive and less staff-intensive treatments are the foundation of a profitable spa.

### ROOM DESIGN

Create a harmonious atmosphere in which both the guest and the therapist can be comfortable. You can achieve a great deal with little means by using intelligent interior architecture. Only invest in expensive decor, ceramics or furnishings if there is ample budget.

### HARDWARE = TREATMENT APPLIANCES

The cost-effectiveness of a spa installation is increased by offering treatments where therapist input is kept to a minimum. Manual treatments such as massages or beauty treatments are essential components of a spa menu and can be perfectly complemented with a Thermo-Spa for floatation and soft pack treatments, and a Wellness bath or shower for a relaxing and revitalising bathing experience.

### QUALITY OF TREATMENTS

If you offer a bathing experience, it needs to be in a special Wellness bath that truly spoils your guest with underwater massage, sound wave massage and coloured light. A unique experience that cannot be recreated at home!

### SPA RECEPTION

The spa reception is of central importance and should be located in a place where many people pass by. The person responsible here must be able to sell. By establishing the guest's wishes, they can sell the appropriate treatment. Volume and the returns are governed by the booking efficiency of the spa reception team and by their ability to optimise capacity.

### COMPETENT STAFF

Qualified staff is the basic prerequisite for a prosperous spa. Bear in mind that your team should know all the treatments on the menu. Inviting them to experience them themselves is the best way to ensure they can sell treatments in a convincing way.

### ADVERTISEMENT IN-HOUSE FOR THE SPA

Offering hotel guests a voucher for a treatment free of charge on their arrival is an ideal way of attracting business to the spa. If you offer a short session in a Thermo-Spa without any products, at little cost to the operation, you have a good opportunity to upsell the guest a paying treatment. If you have short notice availability in the spa this can be advertised as „Last Minute Wellness“ in high footfall places such as in the hotel lobby, elevators, lounge, etc.



# World-renowned and highly rated.

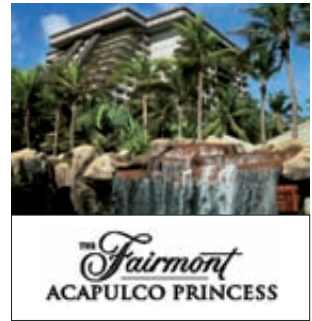

## THE WORLD TRUSTS TRAUTWEIN.

...especially when it comes to high-end products for the wellness industry, physical therapy and nursing. Trautwein baths and wellness systems are installed in hotels, physiotherapy surgeries, nursing homes and private homes – anywhere people like to relax or enjoy a treatment.

Over 10,000 satisfied customers all over the world value our expertise and ability to meet individual needs – in design and functionality. Trautwein stands for wellbeing in every respect. Here you will find a selection of internationally renowned hotels that pamper their guests with Trautwein products.



# We take a responsible approach.



## 100 PERCENT SOLAR.

We take a responsible approach to the environment and the next generation. Our 1.800 m<sup>2</sup> solar power plant generates about 190.000 kwh/year of environmentally friendly power, which is the equivalent of the annual electricity consumption of 65 four-person homes.

We produce far more energy than we ourselves require. In 2002, Trautwein GmbH even received an award from the WWF for its commitment to the environment. We try to reduce waste and limit the impact of our products on the environment, from product development to packaging.



Trautwein GmbH  
Denzlinger Strasse 12  
79312 Emmendingen  
Germany

Tel. +49 (0) 7641/46 77-30  
Fax +49 (0) 7641/46 77-70  
info@trautwein-gmbh.com  
www.trautwein-gmbh.com

Technology for the senses. **TRAUTWEIN**